

規格書



SPECIFICATION

品名
STYLE NAME : REDUNDANT SWITCHING POWER SUPPLY

型號
MODEL NO. : MRW-5600V4V

料號
PART NO. :

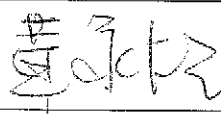
版次
REVISION : A1

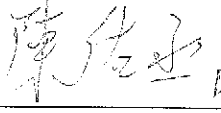
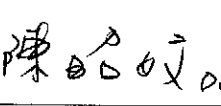
APPROVE 核准	 DEC. 08. 2009	正式資料用章	
CHECK BY 審核	 DEC. 07. 2009		
FORM MAKER 經辦	 DEC. 07. 2009		

新巨企業股份有限公司
電源事業處
ZIPPY TECHNOLOGY CORP.
POWER DIVISION

10F, NO. 50 MIN CHYUAN RD.,
SHIN-TIEN CITY, TAIPEI HSIEN,
TAIWAN, R.O.C.
TEL. : +886(2)29188512
FAX. : +886(2)29134969

Revision

Rev.	Page	Item	Date	Description

MODEL NO. MRW-5600V4V

- 1.0 Scope
- 2.0 Input requirements
 - 2.1 Voltage
 - 2.2 Frequency
 - 2.3 Steady-state current
 - 2.4 Inrush current
 - 2.5 Power factor correction
- 3.0 Output requirements
 - 3.1 DC load requirements
 - 3.2 Regulation and protection
 - 3.3 Ripple and noise
 - 3.3.1 Specification
 - 3.3.2 Ripple voltage test circuit
 - 3.3.3 Ripple & Noise voltage test circuit
 - 3.4 Overshoot
 - 3.5 Efficiency
 - 3.6 Typical Distribution of Efficiency
- 4.0 Protection
 - 4.1 Input
 - 4.2 Output
 - 4.2.1 OPP
 - 4.2.2 OVP
 - 4.2.3 Over current protection
 - 4.2.4 Short current
- 5.0 Power supply sequencing
 - 5.1 Turn on
 - 5.2 Hold up time
 - 5.3 Power off sequence
- 6.0 Signal requirements
 - 6.1 Power good signal
 - 6.2 Under voltage sense level
 - 6.3 Remote on/off control
- 7.0 Environment
 - 7.1 Temperature
 - 7.2 Humidity
 - 7.3 Insulation resistance
 - 7.4 Dielectric withstanding voltage
 - 7.5 Leakage current

8.0 Safety

- 8.1 UL & UL+C
- 8.2 TUV
- 8.3 CCC
- 8.4 Power Line Transient
- 8.5 RFI / EMI Standards

9.0 Reliability

- 9.1 Burn in

10.0 Mechanical requirements

11.0 About module test

12.0 Derating characteristics (Single Module)

- 12.1 Output power derating characteristics

13.0 Output voltage Timing

1.0 Scope

This specification defines the performance characteristics of a grounded , single-phase , 600 watts , 5 output level power supply. This specification also defines world wide safety requirements and manufactures process test requirements.

MRW-5600V4V power system is a 1+1 Redundant power system consisting of two MRW-3600V-R power modules and one MRW-5600V4V power system frame.

2.0 Input requirements

2.1 Voltage (sinusoidal)

Full range 100~240 VAC (With ±10% tolerance)

2.2 Frequency

The input frequency range will be 47~63Hz.

2.3 Steady-state current

9 / 4 amps maximum at any low/high range input voltage.

2.4 Inrush current

25 / 50 amps @132/264 VAC (at 25 degrees ambient cold start)

2.5 Power factor correction

PFC can reach the target of 95% @110V,full load, following the standard of EN 61000-3-2, class D.

3.0 Output requirements

3.1 DC load requirements

Normal Output voltage	Load current		Regulation tolerance	
	Max.	Min	Max.	Min.
+3.3V	25	1.0	+5%	-5%
+5V	25	1.0	+5%	-5%
+12V	49	1.0	+5%	-5%
-12V	0.8	0.0	+5%	-5%
+5VSB	3.5	0.1	+5%	-5%

REMARK: 1. POWER MODULE TOTAL OUTPUT POWER OF +5V AND +3.3V NOT EXCEED 170W.

2. TOTAL OUTPUT POWER NOT EXCEED 600W.

When doing the cross regulation test(one output channel at high load and the other output channels at low load), it is requested to set the higher output channel at 80% max. of its spec., and the lower output channels at 20% max. of theirs.

3.2 Regulation

Output DC voltage	Line regulation	Load regulation	Cross regulaion
+3.3V	±50mV	±165mV	±165mV
+5V	±50mV	±250mV	±250mV
+12V	±50mV	±600mV	±600mV
-12V	±50mV	±600mV	±600mV
+5Vsb	±50mV	±250mV	±250mV

3.3 Ripple and noise

3.3.1 Specification

Parameter	Ripple	Ripple+Noise
+3.3V	50mV(P-P)	50mV(P-P)
+5V	50mV(P-P)	50mV(P-P)
+12V	120mV(P-P)	120mV(P-P)
-12V	120mV(P-P)	120mV(P-P)
+5Vsb	50mV(P-P)	50mV(P-P)

3.3.2 Ripple voltage test circuit

The output ripple/noise is measured at the pins of the output connector terminated with a 0.1 μ F ceramic capacitor and a 100 μ F electrolytic capacitor to simulate system loading, per shown in Figure 1. The test can be performed under any condition of line voltage, output load, line frequency, operation temperature.

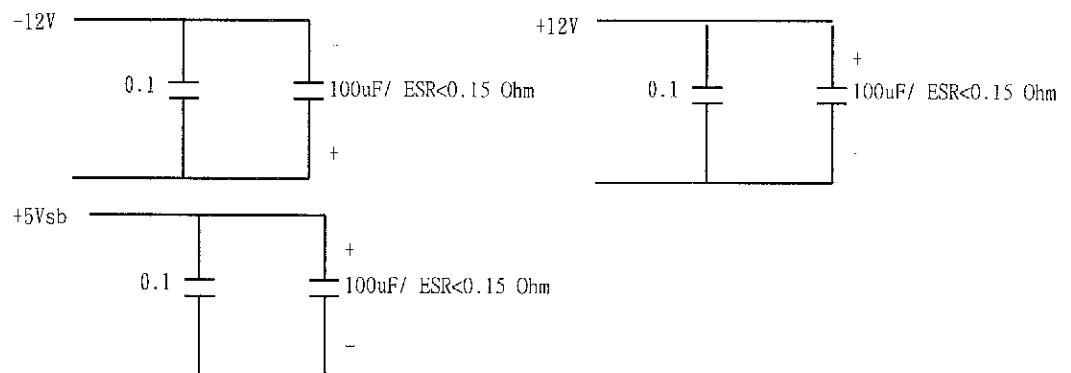

3.3.3 Ripple & noise voltage test circuit

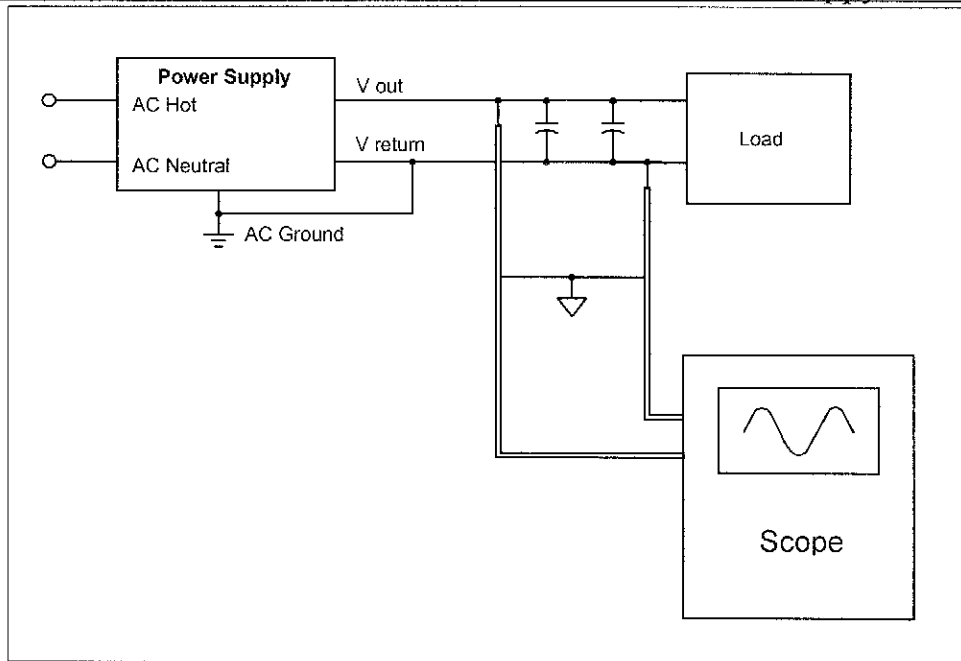

Noise bandwidth is from DC to 20MHZ

3.4 Overshoot

Any overshoot at turn on or turn off shall be less than 10% of the nominal voltage value , all output shall be within the regulation limit of section 3.1 before issuing the power good signal of section 6.0.

3.5 Efficiency

Power supply efficiency typical .>80% at 115V , 20% ~ 100% max load.

3.6 Typical Distribution of Efficiency

3.7 20% Max load, Efficiency test condition @ Ambient temperature 30 degrees							
Voltage	+12V	+5V	-12V	+3.3V	+5VSB	AC INPUT Voltage	
						115V	230V
Load	7.15A	3.65A	0.12A	3.65A	0.51A	>80%	>82%
50% Max load, Efficiency test condition @ Ambient temperature 30 degrees							
Voltage	+12V	+5V	-12V	+3.3V	+5VSB	AC INPUT Voltage	
						115V	230V
Load	17.87A	9.12A	0.29A	9.12A	1.28A	>85%	>87%
100% Max load, Efficiency test condition @ Ambient temperature 30 degrees							
Voltage	+12V	+5V	-12V	+3.3V	+5VSB	AC INPUT Voltage	
						115V	230V
Load	35.74A	18.23A	0.58A	18.23A	2.55A	>83%	>86%

NOTE:

Any difference either on the DC output cable (i.e., length, wire gauge) or on the accurate of instruments will conclude different test result.

4.0 Protection

4.1 Input (primary)

The input power line must have an over power protection device in accordance with safety requirement of section 8.0

4.2 Output (secondary)

4.2.1 Over power protection

The power supply shall provide over power protection on the power supply latches all DC output into a shutdown state. Over power of this type shall cause no damage to power supply , after over load is removed and a power on/off cycle is initiated , the power supply will restart.

Trip point total power min. 110% , max. 160%.

4.2.2 Over voltage protection

If an over voltage fault occurs (internal of the power supply) , the power supply will latch all DC output into a shutdown state.

Output DC voltage	Min	Typical	Max
+3.3V	3.6V	4.0V	4.3V
+5V	5.5V	6.0V	6.5V
+12V	13.2V	14.4V	15.6V

4.2.3 Over current protection

If an over current fault occurs, the power supply will latch all DC output into a shutdown state.

Output DC Current	Min	Typical	Max
+3.3V	27.5A	31.25A	40A
+5V	27.5A	31.25A	40A

4.2.4 Short circuit (This has to test the modules and backplane together)

A: A short circuit placed on any DC output to DC return shall cause no damage.

B: The power supply shall be latched in case any short circuit is taken place at +12V,-12V output.

C: The power supply shall be auto-recovered in case any short circuit is taken place at +5VSB.

5.0 Power supply sequencing

5.1 Power on (see fig.1)

5.2 Hold up time

When power shutdown DC output 12V must be maintain 16msec in regulation limit at normal input voltage.

5.3 Power off sequence (see fig. 1)

6.0 Signal requirements

6.1 Power good signal (see fig. 1)

The power supply shall provide a "power good" signal to reset system logic, indicate proper operation of the power supply, and give advance warning of impending loss of regulation at turn off. This signal shall be a TTL compatible up level (2.4V to 5.25V) when +12V output voltage are present and above the minimum UV sense levels specified in paragraph 6.2, or a down level (0.0V to 0.8V) when any output is below its minimum UV sense level.

At power on, the power good signal shall have a turn on delay of at least 100ms but not greater than 500ms after the output voltages have reached their respective minimum sense levels.

6.2 Under voltage (UV) sense levels

Output	Minimum sense voltage
+12V	+8.0V

6.3 Remote on/off control

The power supply DC outputs (with the exception of +5VSB) shall be enabled with an active-low, TTL-compatible signal ("PS-ON")

When PS-ON is pulled to TTL low, the DC outputs are to be enabled.

When PS-ON is pulled to TTL high or open circuited, the DC outputs are to be disabled.

7.0 Environment

7.1 Temperature

Operating temperature	0 to 50 degrees centigrade
Non-Operating temperature	-20 to 80 degrees centigrade
Safety regulation temperature	Applied at room temperature (25°C)

7.2 Humidity

Operating humidity	20% to 80%
Non-operating humidity	10% to 90%

7.3 Insulation resistance

Primary to secondary	: 100 meg. ohm min. 500 VDC
Primary to Frame Gnd	: 100 meg. ohm min. 500 VDC

7.4 Dielectric withstanding voltage

For approval purpose :

Primary to secondary	: 3KVAC for 1min.
Primary to Frame Gnd	: 1500 VAC for 1 min.

For production purpose: 100% test

Primary to Frame Gnd	: 1500VAC for 1 sec
Cut off current	: 15mA

7.5 Leakage current

3.5 mA. max. at nominal voltage 250 VAC

8.0 Safety

The power supply must be certified to the safety standard listed following:

8.1 Recognized to U.S. and Canadian requirements under the component recognition program of Underwriters Laboratories Inc.

The power supply shall be designed to meet UL 60950-1.

8.2 TUV approval TUV EN-60950.

CB approval IEC-60950.

8.3 Certificate for China compulsory product certification

GB4943,GB9254,GB17625.1.

8.4 Power Line Transient.

The power supply shall be designed to meet the following standards

1. EN 61000-4-2(ESD) Criterion B, $\pm 4\text{KV}$ by contact, $\pm 8\text{KV}$ by air.

2. EN 61000-4-4(EFT) Criterion B, $\pm 1\text{KV}$.

3. EN 61000-4-5(SURGE) Criterion B, Line-Line $\pm 1\text{KV}$

Line-Earth $\pm 2\text{KV}$.

8.5 RFI / EMI Standards

The power supply shall comply with the following radiated and conducted Emissions standards,

1. FCC part 15. class B.

2. CISPR 22 (EN 55022:2006). class B.

9.0 Reliability

9.1 Burn in

All products shipped to customer must be processed by burn-in. The burn- in shall be performed for 1 hour at full load.

10.0 Mechanical requirements

Physical dimension : 185mm * 150mm * 86mm (D *W* H)

11.0 About module test

Module test : all modules should test with backplane.

12.0 Derating characteristics(Single Module)

12.1 Output power derating characteristics

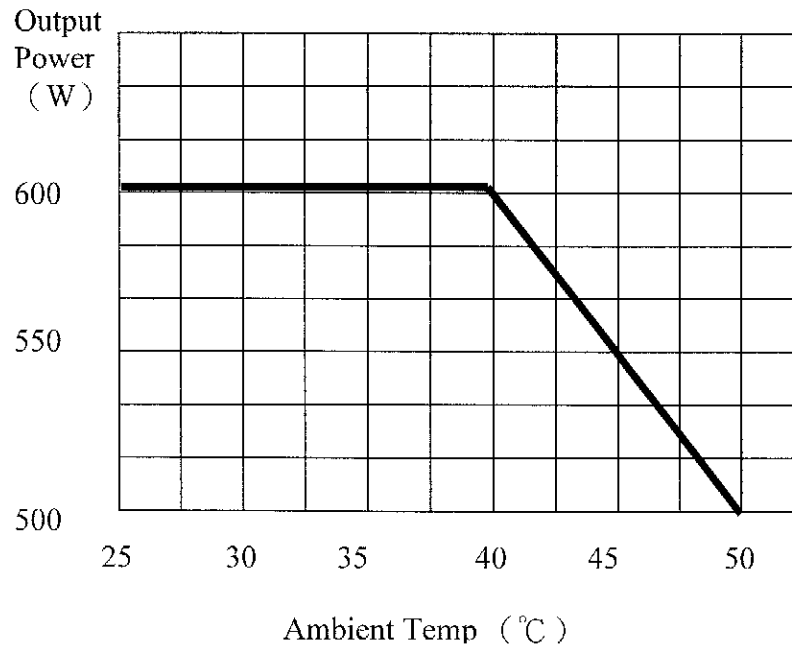

13.0 Output voltage timing

Item	Description	MIN	MAX	UNITS
Tsb_on_delay	Delay from AC being applied to 5VSB being within regulation.		1500	ms
Tac_on_delay	Delay from AC being applied to all output voltages being within regulation.		2500	ms
Tvout_holdup	Time all output voltages stay within regulation after loss of AC.	18		ms
Tpwok_holdup	Delay from loss of AC to deassertion of PWOK.	16		ms
Tpson_on_delay	Delay from PSON# active to output voltages within regulation limits.	2	400	ms
Tpson_pwok	Delay from PSON# deactive to PWOK being deasserted.		50	ms
Tpwok_on	Delay from output voltages within regulation limits to PWOK asserted at turn on.	100	500	ms
Tpwok_off	Delay from PWOK deasserted to output voltages (3.3V, 5V, 12V, -12V) dropping out of regulation limits.	1		ms
Tsb_vout	Delay from 5VSB being in regulation to O/Ps being in regulation at AC turn on.	2	1000	ms
Tsb_holdup	Time 5VSB output voltage stays within regulation after loss of AC.	70		ms
Tvout_rise	Output voltage rise time from each main output.	2	20	ms

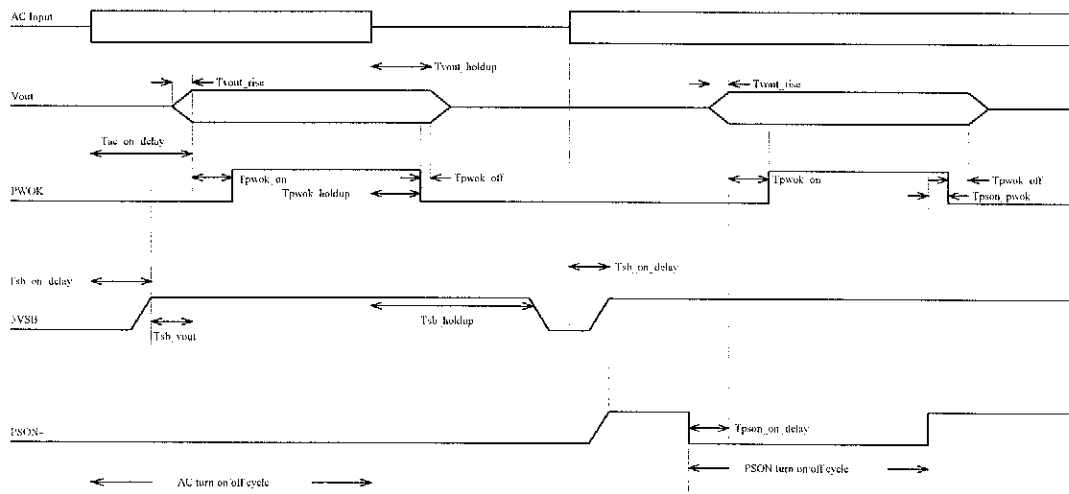

Fig.1